

CGH40035F

35 W, DC - 4 GHz, RF Power GaN HEMT

Cree's CGH40035F is an unmatched, gallium nitride (GaN) high electron mobility transistor (HEMT). The CGH40035F, operating from a 28 volt rail, offers a general purpose, broadband solution to a variety of RF and microwave applications. GaN HEMTs offer high efficiency, high gain and wide bandwidth capabilities making the CGH40035F ideal for linear and compressed amplifier circuits. The transistor is available in a screw-down, flange package.

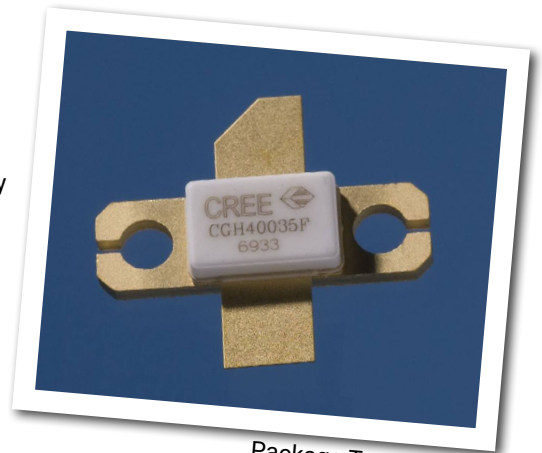

Package Type: 440193
PN: CGH40035F

FEATURES

- Up to 4 GHz Operation
- 15 dB Small Signal Gain at 2.0 GHz
- 13 dB Small Signal Gain at 4.0 GHz
- 45 W typical P_{SAT}
- 60 % Efficiency at P_{SAT}
- 28 V Operation

APPLICATIONS

- 2-Way Private Radio
- Broadband Amplifiers
- Cellular Infrastructure
- Test Instrumentation
- Class A, AB, Linear amplifiers suitable for OFDM, W-CDMA, EDGE, CDMA waveforms



Absolute Maximum Ratings (not simultaneous) at 25°C Case Temperature

Parameter	Symbol	Rating	Units	Conditions
Drain-Source Voltage	V_{DSS}	84	Volts	25°C
Gate-to-Source Voltage	V_{GS}	-10, +2	Volts	25°C
Storage Temperature	T_{STG}	-65, +150	°C	
Operating Junction Temperature	T_J	225	°C	
Maximum Forward Gate Current	I_{GMAX}	10.0	mA	25°C
Maximum Drain Current ¹	I_{DMAX}	4.5	A	25°C
Soldering Temperature ²	T_S	245	°C	
Screw Torque	τ	80	in-oz	
Thermal Resistance, Junction to Case ³	$R_{\theta JC}$	3.0	°C/W	85°C
Case Operating Temperature ^{3,4}	T_C	-40, +150	°C	

Note:

¹ Current limit for long term, reliable operation

² Refer to the Application Note on soldering at www.cree.com/RF/Document-Library

³ Measured for the CGH40035F at $P_{DISS} = 42$ W.

⁴ See also, the Power Dissipation De-rating Curve on Page 6.

Electrical Characteristics ($T_C = 25^\circ\text{C}$)

Characteristics	Symbol	Min.	Typ.	Max.	Units	Conditions
DC Characteristics¹						
Gate Threshold Voltage	$V_{GS(th)}$	-3.8	-3.0	-2.3	V_{DC}	$V_{DS} = 10$ V, $I_D = 10.8$ mA
Gate Quiescent Voltage	$V_{GS(Q)}$	-	-2.7	-	V_{DC}	$V_{DS} = 28$ V, $I_D = 500$ mA
Saturated Drain Current	I_{DS}	8.7	10.5	-	A	$V_{DS} = 6.0$ V, $V_{GS} = 2.0$ V
Drain-Source Breakdown Voltage	V_{BR}	120	-	-	V_{DC}	$V_{GS} = -8$ V, $I_D = 10.8$ mA
RF Characteristics² ($T_C = 25^\circ\text{C}$, $F_0 = 3.5$ GHz unless otherwise noted)						
Small Signal Gain	G_{SS}	13	14	-	dB	$V_{DD} = 28$ V, $I_{DQ} = 500$ mA
Power Output ³	P_{SAT}	30	45	-	W	$V_{DD} = 28$ V, $I_{DQ} = 500$ mA
Drain Efficiency ⁴	η	50	60	-	%	$V_{DD} = 28$ V, $I_{DQ} = 500$ mA, P_{SAT}
Output Mismatch Stress	VSWR	-	-	10 : 1	Ψ	No damage at all phase angles, $V_{DD} = 28$ V, $I_{DQ} = 500$ mA, $P_{OUT} = 35$ W CW
Dynamic Characteristics						
Input Capacitance	C_{GS}	-	14.7	-	pF	$V_{DS} = 28$ V, $V_{gs} = -8$ V, $f = 1$ MHz
Output Capacitance	C_{DS}	-	4.9	-	pF	$V_{DS} = 28$ V, $V_{gs} = -8$ V, $f = 1$ MHz
Feedback Capacitance	C_{GD}	-	0.6	-	pF	$V_{DS} = 28$ V, $V_{gs} = -8$ V, $f = 1$ MHz

Notes:

¹ Measured on wafer prior to packaging.

² Measured in CGH40035F-AMP

³ P_{SAT} is defined as $I_G = 1.08$ mA.

⁴ Drain Efficiency = P_{OUT} / P_{DC}

Typical Performance

Simulated Small Signal Gain and Input Return Loss of the CGH40035F-AMP vs Frequency
 $V_{DD} = 28\text{ V}, I_{DQ} = 500\text{ mA}$

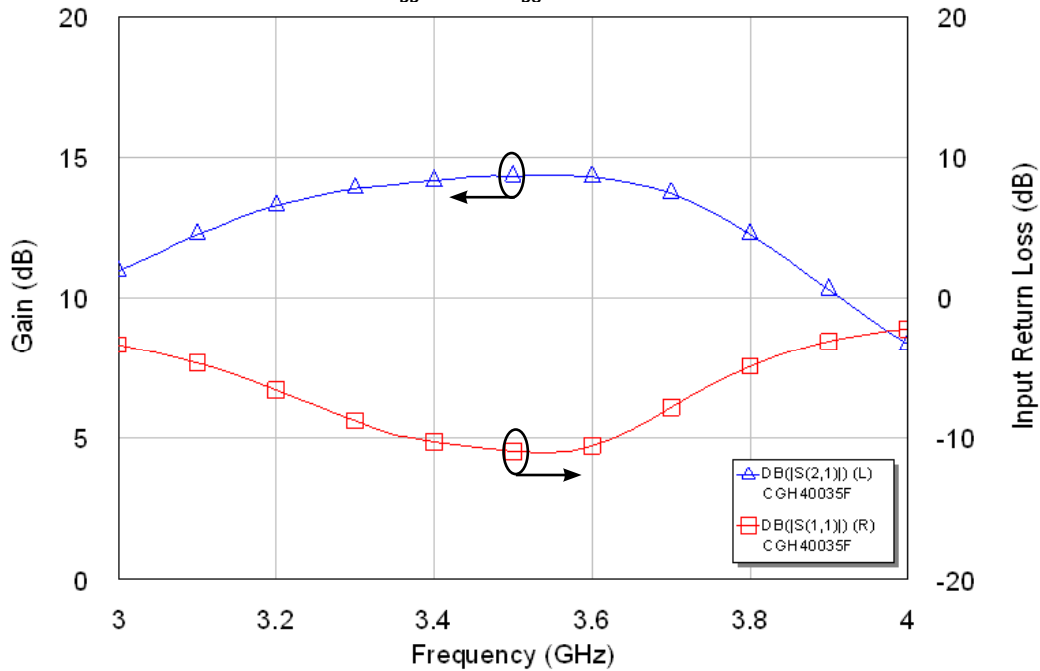

P_{SAT} Gain, and Drain Efficiency vs Frequency of the CGH40035F in the CGH40035F-AMP
 $V_{DD} = 28\text{ V}, I_{DQ} = 500\text{ mA}$

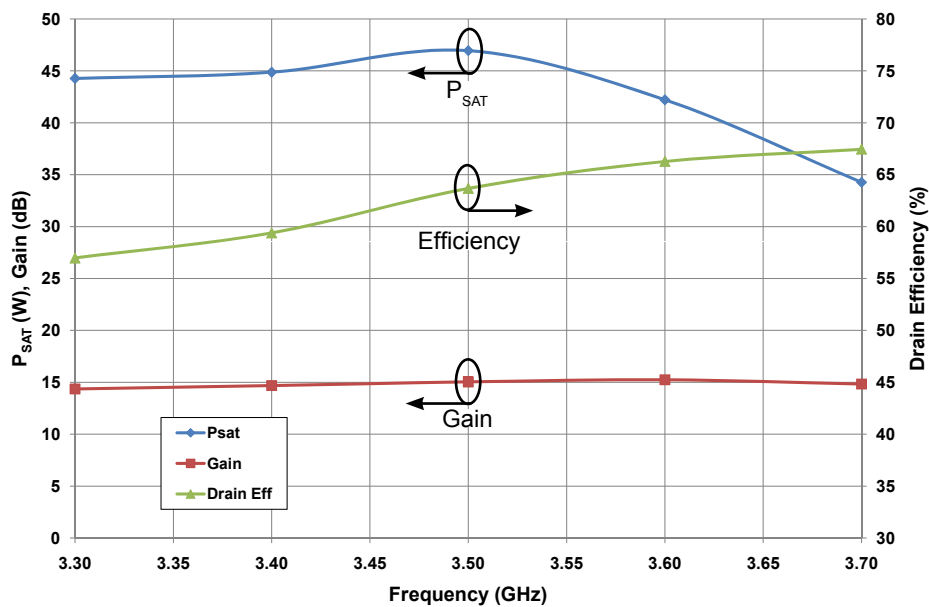

Typical Performance

Swept CW Data of CGH40035 vs. Output Power with Source and Load Impedances Optimized for P_{SAT} Power in CGH40035F-AMP
 $V_{DD} = 28\text{ V}$, $I_{DQ} = 500\text{ mA}$, Freq = 3.5 GHz

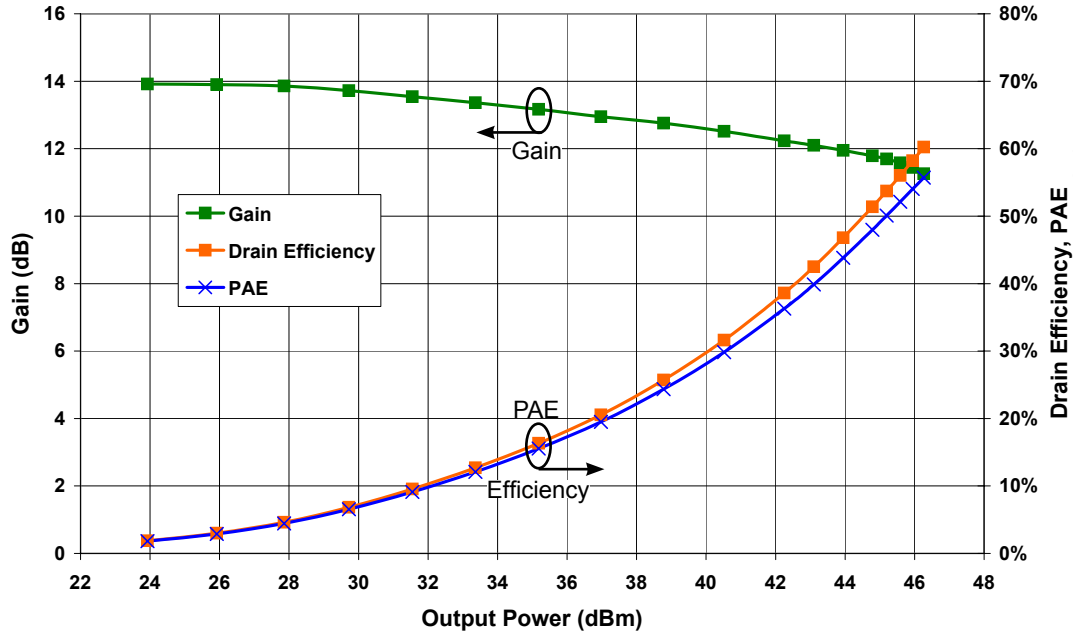

Simulated Maximum Available Gain and K Factor of the CGH40035F
 $V_{DD} = 28\text{ V}$, $I_{DQ} = 500\text{ mA}$

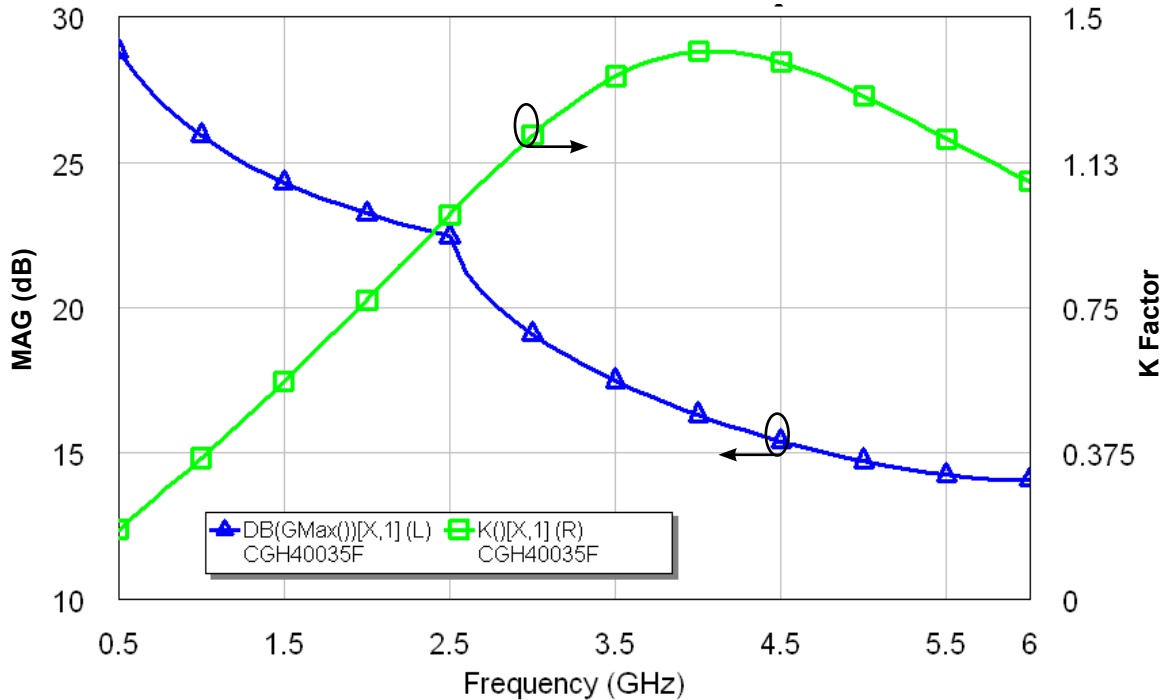

Typical Noise Performance

Simulated Minimum Noise Figure and Noise Resistance vs Frequency of the CGH40035F
 $V_{DD} = 28\text{ V}$, $I_{DQ} = 500\text{ mA}$

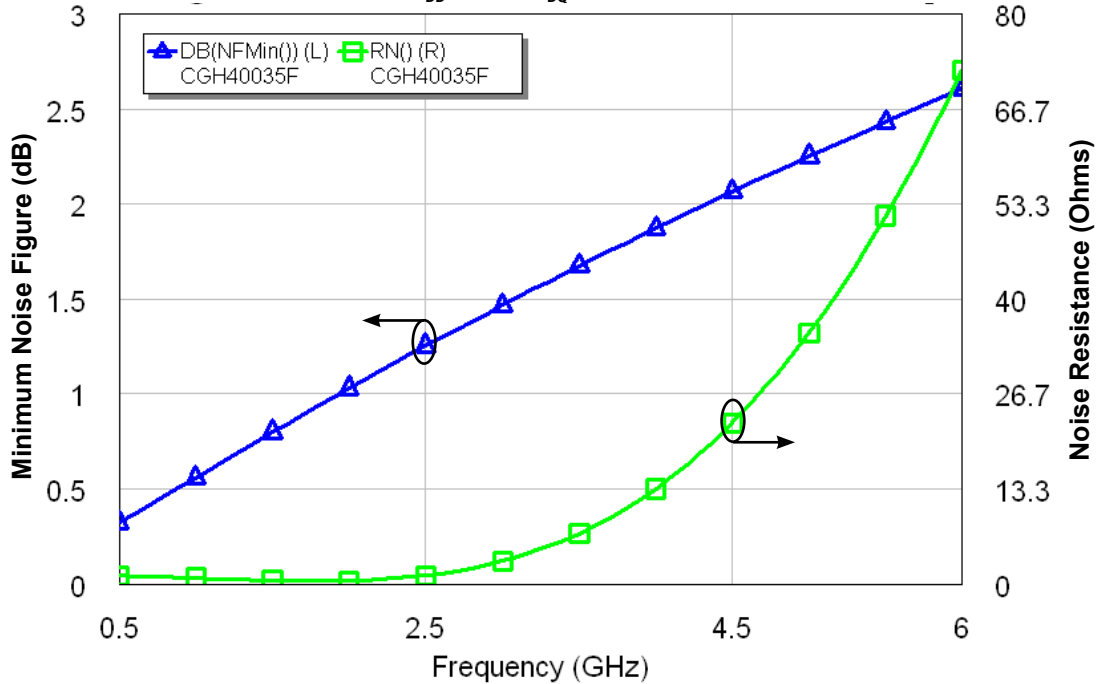

Electrostatic Discharge (ESD) Classifications

Parameter	Symbol	Class	Test Methodology
Human Body Model	HBM	1A > 250 V	JEDEC JESD22 A114-D
Charge Device Model	CDM	1 < 200 V	JEDEC JESD22 C101-C

Source and Load Impedances



Frequency (MHz)	Z Source	Z Load
500	5.12 + j8.3	15.5 + j5.67
1000	2.97 + j1.38	11.29 + j7.27
1500	1.15 - j0.38	6.6 + j5.56
2500	0.91 - j5.13	6.17 - j0.4
3500	2.0 - j9.9	4.78 - j2.58

Note 1. $V_{DD} = 28V$, $I_{DQ} = 500mA$, in the 440193 package.

Note 2. Optimized for power gain, P_{SAT} and PAE.

Note 3. When using this device at low frequency, series resistors should be used to maintain amplifier stability.

CGH40035F Power Dissipation De-rating Curve

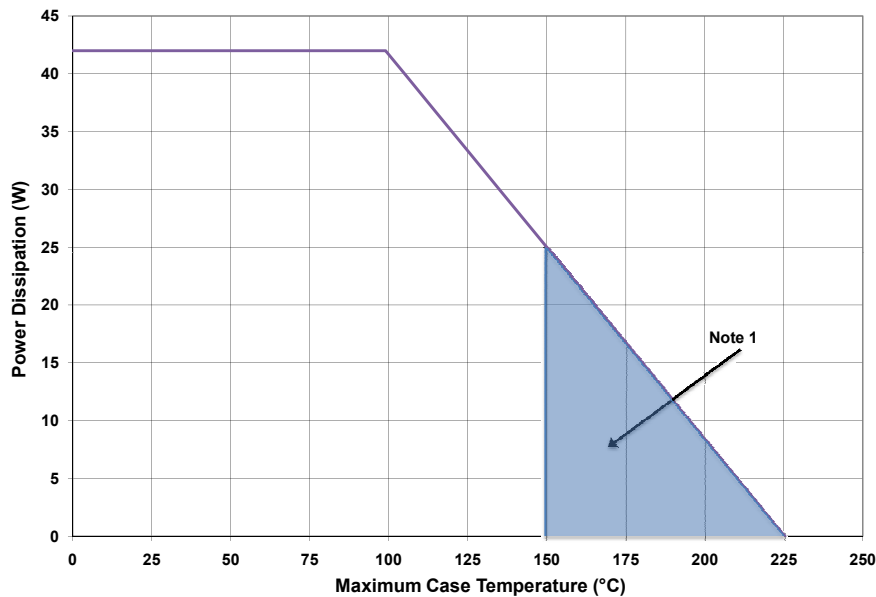

Note 1. Area exceeds Maximum Case Operating Temperature (See Page 2).

CGH40035F-AMP Demonstration Amplifier Circuit Schematic

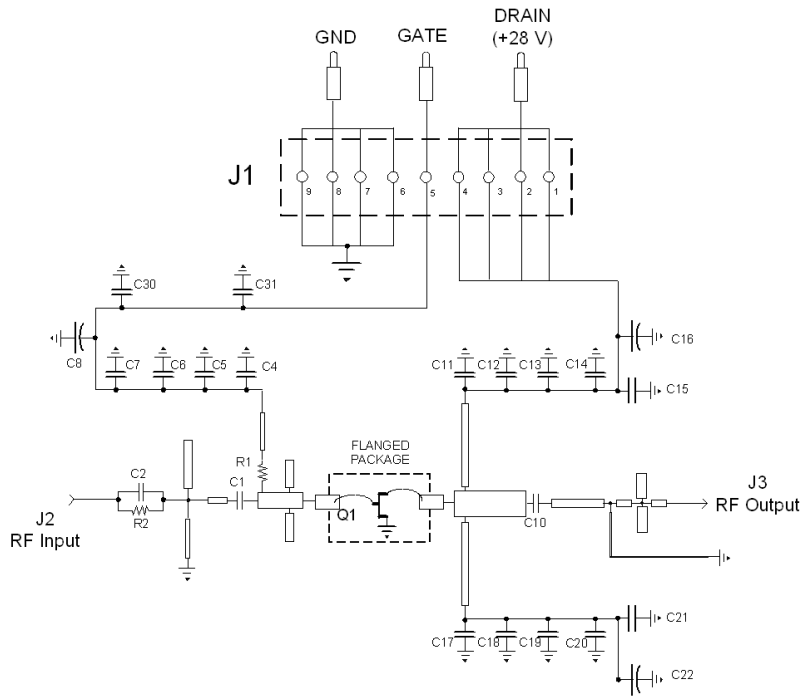

CGH40035F-AMP Demonstration Amplifier Circuit Outline

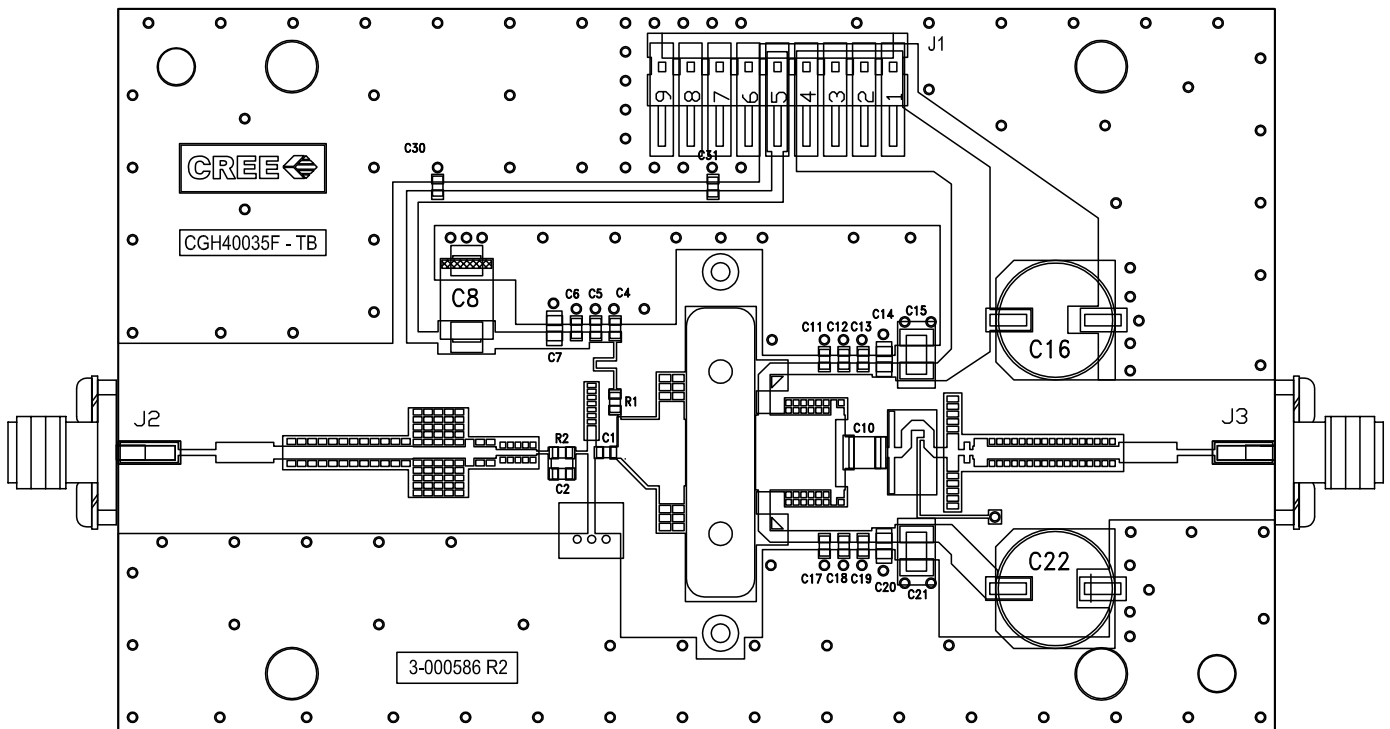

CGH40035F-AMP Demonstration Amplifier Circuit Bill of Materials

Designator	Description	Qty
R1	RES, 1/16W, 0603, $\leq 5\%$, 5.1 OHMS	1
R2	RES, 1/16W, 0603, 1%, 100 OHMS	1
C6,C13,C19	CAP, 470PF, 5%, 100V, 0603	3
C16,C22	CAP, 33 UF, 20%, G CASE	2
C15,C21	CAP, 1.0UF, 100V, 10%, X7R, 1210	2
C8	CAP 10UF 16V TANTALUM	1
C1	CAP, 0.6pF, +/-0.05pF, 0603	1
C2	CAP, 1.2pF, +/-0.1pF, 0603	1
C10	CAP 4.7PF, +/- 0.25pF, ATC 100B	1
C4,C11,C17	CAP, 7.5pF, +/-0.1pF, 0603	3
C5,C12,C18,C30,C31	CAP, 47pF,+/-5%pF, 0603	5
C7,C14,C20	CAP,33000PF, 0805,100V, X7R	3
J2,J3	CONN SMA STR PANEL JACK RECP	2
J1	HEADER RT>PLZ .1CEN LK 9POS	1
-	PCB, R04350B, Er = 3.48, h = 20 mil	1
Q1	CGH40035F	1

CGH40035F-AMP Demonstration Amplifier Circuit

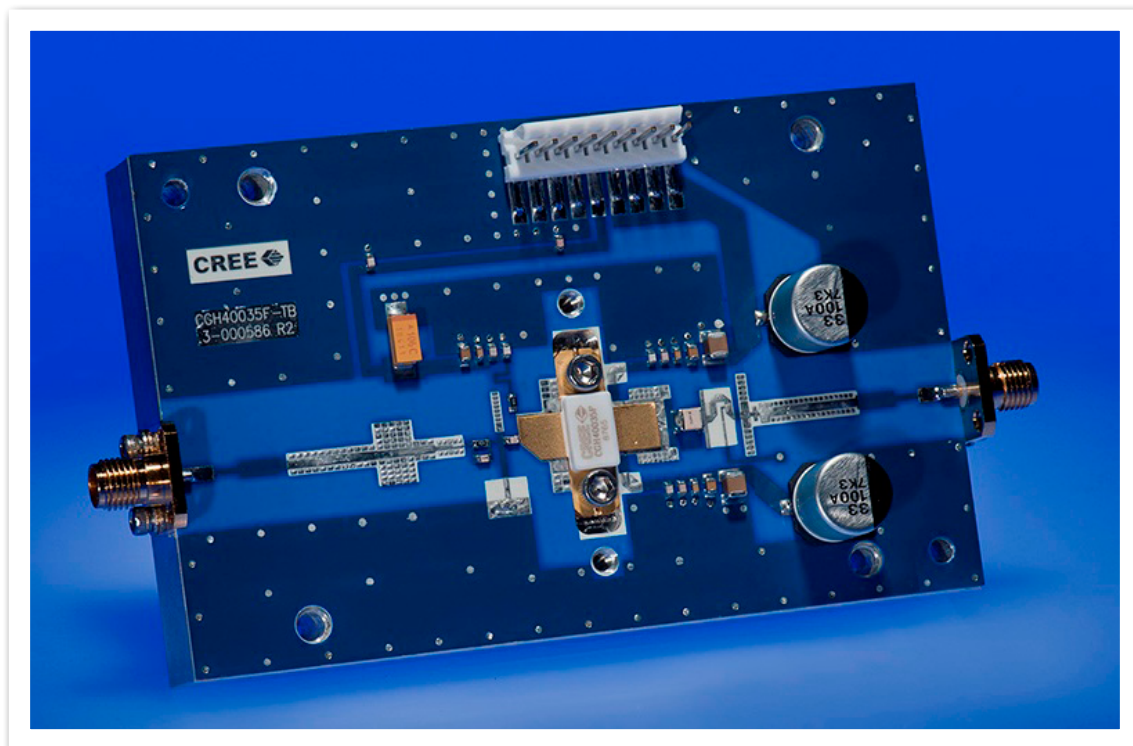

Typical Package S-Parameters for CGH40035F
 (Small Signal, $V_{DS} = 28\text{ V}$, $I_{DQ} = 250\text{ mA}$, angle in degrees)

Frequency	Mag S11	Ang S11	Mag S21	Ang S21	Mag S12	Ang S12	Mag S22	Ang S22
500 MHz	0.921	-166.38	9.09	82.39	0.015	-1.84	0.555	-165.89
600 MHz	0.921	-169.49	7.57	78.16	0.015	-4.89	0.564	-166.40
700 MHz	0.922	-171.87	6.47	74.31	0.015	-7.54	0.574	-166.63
800 MHz	0.922	-173.79	5.65	70.73	0.015	-9.90	0.583	-166.74
900 MHz	0.923	-175.42	5.00	67.35	0.015	-12.05	0.593	-166.81
1.0 GHz	0.923	-176.84	4.49	64.12	0.014	-14.02	0.604	-166.89
1.1 GHz	0.924	-178.11	4.06	61.01	0.014	-15.84	0.614	-166.99
1.2 GHz	0.925	-179.29	3.71	58.01	0.014	-17.52	0.625	-167.14
1.3 GHz	0.925	179.62	3.41	55.10	0.014	-19.07	0.635	-167.34
1.4 GHz	0.926	178.57	3.16	52.28	0.014	-20.50	0.645	-167.59
1.5 GHz	0.927	177.57	2.94	49.54	0.014	-21.81	0.656	-167.90
1.6 GHz	0.927	176.59	2.75	46.86	0.013	-23.01	0.665	-168.25
1.7 GHz	0.928	175.62	2.58	44.26	0.013	-24.09	0.675	-168.65
1.8 GHz	0.928	174.67	2.43	41.71	0.013	-25.06	0.684	-169.08
1.9 GHz	0.928	173.72	2.30	39.21	0.013	-25.91	0.692	-169.56
2.0 GHz	0.929	172.76	2.19	36.77	0.013	-26.65	0.700	-170.07
2.1 GHz	0.929	171.80	2.09	34.37	0.012	-27.27	0.708	-170.61
2.2 GHz	0.929	170.83	2.00	32.01	0.012	-27.77	0.715	-171.18
2.3 GHz	0.928	169.84	1.92	29.69	0.012	-28.16	0.721	-171.77
2.4 GHz	0.928	168.83	1.85	27.40	0.012	-28.43	0.727	-172.38
2.5 GHz	0.928	167.80	1.78	25.14	0.012	-28.59	0.733	-173.02
2.6 GHz	0.927	166.74	1.73	22.89	0.012	-28.62	0.738	-173.67
2.7 GHz	0.926	165.64	1.68	20.66	0.012	-28.53	0.743	-174.33
2.8 GHz	0.925	164.51	1.63	18.45	0.012	-28.32	0.747	-175.02
2.9 GHz	0.924	163.34	1.59	16.24	0.012	-27.99	0.751	-175.72
3.0 GHz	0.923	162.12	1.56	14.03	0.012	-27.54	0.754	-176.43
3.2 GHz	0.919	159.52	1.51	9.58	0.012	-26.32	0.759	-177.91
3.4 GHz	0.914	156.66	1.48	5.07	0.012	-24.69	0.762	-179.44
3.6 GHz	0.908	153.49	1.46	0.42	0.012	-22.78	0.764	178.96
3.8 GHz	0.901	149.91	1.46	-4.42	0.013	-20.73	0.764	177.29
4.0 GHz	0.891	145.85	1.47	-9.52	0.014	-18.75	0.761	175.54
4.2 GHz	0.879	141.16	1.50	-14.99	0.015	-17.12	0.757	173.69
4.4 GHz	0.863	135.68	1.55	-20.92	0.017	-16.10	0.750	171.73
4.6 GHz	0.844	129.19	1.62	-27.45	0.020	-16.00	0.742	169.65
4.8 GHz	0.819	121.39	1.70	-34.74	0.023	-17.08	0.730	167.41
5.0 GHz	0.788	111.88	1.81	-42.97	0.027	-19.60	0.717	164.98
5.2 GHz	0.750	100.13	1.93	-52.34	0.032	-23.79	0.701	162.29
5.4 GHz	0.707	85.49	2.07	-63.07	0.039	-29.84	0.682	159.23
5.6 GHz	0.662	67.25	2.21	-75.29	0.046	-37.88	0.660	155.58
5.8 GHz	0.626	45.06	2.33	-89.03	0.054	-47.89	0.634	151.00
6.0 GHz	0.611	19.67	2.41	-104.14	0.063	-59.66	0.599	144.99

To download the s-parameters in s2p format, go to the [CGH40035F Product Page](#) and click on the documentation tab.

Typical Package S-Parameters for CGH40035F
 (Small Signal, $V_{DS} = 28\text{ V}$, $I_{DQ} = 500\text{ mA}$, angle in degrees)

Frequency	Mag S11	Ang S11	Mag S21	Ang S21	Mag S12	Ang S12	Mag S22	Ang S22
500 MHz	0.933	-168.22	9.15	83.17	0.012	0.59	0.599	-170.98
600 MHz	0.933	-171.13	7.63	79.30	0.012	-1.75	0.604	-171.44
700 MHz	0.933	-173.38	6.54	75.79	0.012	-3.72	0.610	-171.69
800 MHz	0.933	-175.22	5.72	72.50	0.012	-5.44	0.615	-171.82
900 MHz	0.933	-176.78	5.09	69.38	0.012	-6.98	0.621	-171.89
1.0 GHz	0.933	-178.16	4.57	66.38	0.012	-8.36	0.628	-171.96
1.1 GHz	0.934	-179.40	4.16	63.48	0.012	-9.61	0.634	-172.02
1.2 GHz	0.934	179.45	3.81	60.66	0.012	-10.74	0.641	-172.11
1.3 GHz	0.934	178.38	3.52	57.92	0.011	-11.75	0.647	-172.22
1.4 GHz	0.934	177.35	3.26	55.24	0.011	-12.67	0.654	-172.37
1.5 GHz	0.934	176.35	3.05	52.61	0.011	-13.47	0.661	-172.55
1.6 GHz	0.934	175.38	2.86	50.04	0.011	-14.18	0.667	-172.77
1.7 GHz	0.934	174.43	2.70	47.51	0.011	-14.78	0.673	-173.03
1.8 GHz	0.933	173.48	2.55	45.02	0.011	-15.29	0.679	-173.32
1.9 GHz	0.933	172.54	2.43	42.58	0.011	-15.69	0.685	-173.64
2.0 GHz	0.933	171.59	2.32	40.16	0.011	-15.99	0.691	-174.00
2.1 GHz	0.932	170.63	2.22	37.78	0.011	-16.19	0.696	-174.39
2.2 GHz	0.932	169.66	2.13	35.43	0.011	-16.29	0.701	-174.80
2.3 GHz	0.931	168.67	2.05	33.10	0.011	-16.30	0.706	-175.25
2.4 GHz	0.930	167.66	1.98	30.79	0.011	-16.21	0.710	-175.71
2.5 GHz	0.929	166.62	1.92	28.49	0.011	-16.02	0.714	-176.21
2.6 GHz	0.928	165.56	1.86	26.21	0.011	-15.75	0.718	-176.72
2.7 GHz	0.927	164.46	1.81	23.93	0.011	-15.40	0.721	-177.26
2.8 GHz	0.925	163.32	1.77	21.66	0.011	-14.96	0.724	-177.82
2.9 GHz	0.924	162.14	1.73	19.38	0.011	-14.46	0.727	-178.40
3.0 GHz	0.922	160.90	1.70	17.09	0.011	-13.89	0.729	-179.00
3.2 GHz	0.917	158.28	1.65	12.48	0.012	-12.64	0.732	179.75
3.4 GHz	0.912	155.38	1.62	7.77	0.012	-11.30	0.733	178.42
3.6 GHz	0.905	152.15	1.61	2.90	0.013	-10.03	0.733	177.01
3.8 GHz	0.896	148.51	1.61	-2.18	0.014	-8.98	0.731	175.53
4.0 GHz	0.885	144.37	1.63	-7.56	0.016	-8.34	0.726	173.97
4.2 GHz	0.871	139.58	1.67	-13.32	0.018	-8.28	0.720	172.31
4.4 GHz	0.853	133.98	1.73	-19.56	0.020	-8.99	0.712	170.56
4.6 GHz	0.831	127.34	1.80	-26.43	0.023	-10.65	0.701	168.71
4.8 GHz	0.804	119.36	1.89	-34.07	0.027	-13.45	0.688	166.73
5.0 GHz	0.770	109.64	2.01	-42.66	0.032	-17.57	0.673	164.60
5.2 GHz	0.729	97.64	2.14	-52.39	0.038	-23.19	0.656	162.24
5.4 GHz	0.684	82.72	2.28	-63.43	0.045	-30.48	0.637	159.52
5.6 GHz	0.638	64.19	2.41	-75.89	0.052	-39.52	0.615	156.18
5.8 GHz	0.603	41.77	2.53	-89.77	0.061	-50.28	0.587	151.85
6.0 GHz	0.592	16.41	2.59	-104.90	0.069	-62.57	0.551	146.03

To download the s-parameters in s2p format, go to the [CGH40035F Product Page](#) and click on the documentation tab.

Typical Package S-Parameters for CGH40035F
 (Small Signal, $V_{DS} = 28\text{ V}$, $I_{DQ} = 750\text{ mA}$, angle in degrees)

Frequency	Mag S11	Ang S11	Mag S21	Ang S21	Mag S12	Ang S12	Mag S22	Ang S22
500 MHz	0.938	-168.93	9.06	83.42	0.011	1.67	0.616	-172.64
600 MHz	0.938	-171.77	7.56	79.69	0.011	-0.35	0.620	-173.09
700 MHz	0.938	-173.96	6.49	76.30	0.011	-2.03	0.625	-173.35
800 MHz	0.938	-175.76	5.68	73.13	0.011	-3.46	0.629	-173.51
900 MHz	0.938	-177.30	5.05	70.10	0.011	-4.72	0.634	-173.61
1.0 GHz	0.938	-178.66	4.55	67.20	0.011	-5.83	0.639	-173.69
1.1 GHz	0.938	-179.89	4.14	64.38	0.011	-6.82	0.644	-173.77
1.2 GHz	0.938	178.97	3.80	61.63	0.011	-7.70	0.649	-173.86
1.3 GHz	0.938	177.90	3.51	58.96	0.011	-8.47	0.655	-173.98
1.4 GHz	0.938	176.88	3.26	56.33	0.011	-9.15	0.660	-174.12
1.5 GHz	0.937	175.89	3.05	53.76	0.011	-9.72	0.665	-174.28
1.6 GHz	0.937	174.92	2.87	51.23	0.010	-10.21	0.671	-174.48
1.7 GHz	0.937	173.96	2.71	48.74	0.010	-10.60	0.676	-174.71
1.8 GHz	0.936	173.02	2.57	46.28	0.010	-10.89	0.681	-174.97
1.9 GHz	0.936	172.07	2.44	43.86	0.010	-11.10	0.685	-175.26
2.0 GHz	0.935	171.12	2.33	41.47	0.010	-11.22	0.690	-175.58
2.1 GHz	0.935	170.16	2.24	39.10	0.010	-11.24	0.694	-175.93
2.2 GHz	0.934	169.18	2.15	36.76	0.010	-11.19	0.699	-176.30
2.3 GHz	0.933	168.19	2.07	34.43	0.010	-11.05	0.702	-176.70
2.4 GHz	0.932	167.18	2.00	32.12	0.011	-10.83	0.706	-177.13
2.5 GHz	0.931	166.14	1.94	29.81	0.011	-10.54	0.709	-177.58
2.6 GHz	0.930	165.06	1.89	27.52	0.011	-10.18	0.712	-178.06
2.7 GHz	0.928	163.96	1.84	25.23	0.011	-9.76	0.715	-178.55
2.8 GHz	0.927	162.81	1.80	22.94	0.011	-9.28	0.717	-179.07
2.9 GHz	0.925	161.62	1.77	20.64	0.011	-8.77	0.719	-179.61
3.0 GHz	0.923	160.39	1.74	18.33	0.011	-8.23	0.720	179.83
3.2 GHz	0.918	157.74	1.69	13.65	0.012	-7.10	0.722	178.65
3.4 GHz	0.912	154.81	1.66	8.87	0.013	-6.03	0.723	177.40
3.6 GHz	0.904	151.56	1.65	3.92	0.014	-5.15	0.721	176.07
3.8 GHz	0.895	147.88	1.66	-1.26	0.015	-4.59	0.718	174.66
4.0 GHz	0.883	143.69	1.68	-6.74	0.017	-4.52	0.713	173.17
4.2 GHz	0.869	138.85	1.72	-12.62	0.019	-5.08	0.706	171.60
4.4 GHz	0.851	133.18	1.78	-19.00	0.022	-6.42	0.697	169.94
4.6 GHz	0.828	126.46	1.86	-26.01	0.025	-8.72	0.685	168.18
4.8 GHz	0.799	118.38	1.95	-33.80	0.029	-12.12	0.671	166.32
5.0 GHz	0.764	108.54	2.07	-42.55	0.034	-16.81	0.655	164.31
5.2 GHz	0.723	96.40	2.20	-52.44	0.040	-22.96	0.638	162.10
5.4 GHz	0.677	81.32	2.34	-63.62	0.047	-30.70	0.618	159.52
5.6 GHz	0.631	62.63	2.47	-76.21	0.055	-40.13	0.596	156.31
5.8 GHz	0.597	40.10	2.58	-90.17	0.063	-51.20	0.568	152.08
6.0 GHz	0.588	14.75	2.64	-105.34	0.071	-63.71	0.531	146.31

To download the s-parameters in s2p format, go to the [CGH40035F Product Page](#) and click on the documentation tab.

Product Dimensions CGH40035F (Package Type – 440193)

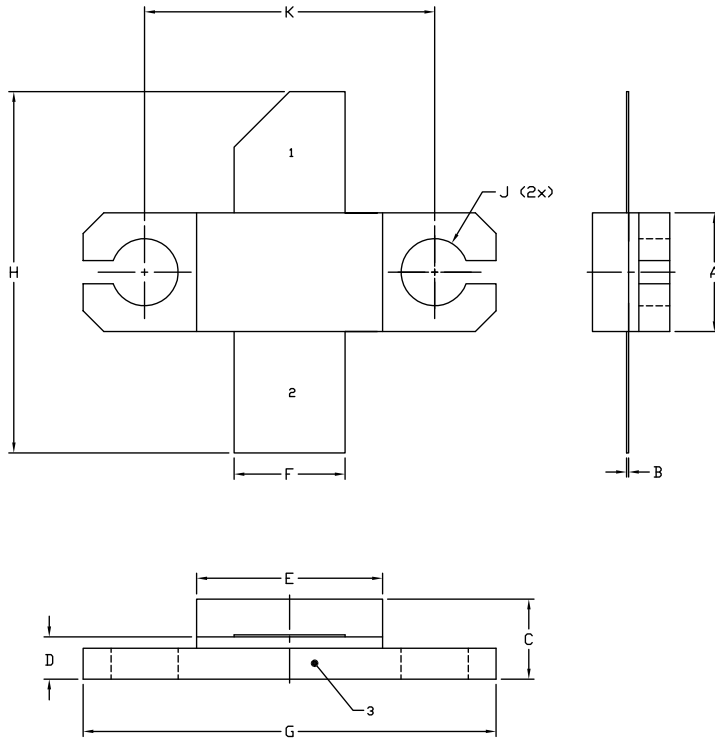

NOTES:

1. DIMENSIONING AND TOLERANCING PER ANSI Y14.5M, 1982.
2. CONTROLLING DIMENSION INCH.
3. ADHESIVE FROM LID MAY EXTEND A MAXIMUM OF 0.020" BEYOND EDGE OF LID.
4. LID MAY BE MISALIGNED TO THE BODY OF THE PACKAGE BY A MAXIMUM OF 0.008" IN ANY DIRECTION.
5. ALL PLATED SURFACES ARE Ni/AU

DIM	INCHES		MILLIMETERS	
	MIN	MAX	MIN	MAX
A	0.225	0.235	5.72	5.97
B	0.004	0.006	0.10	0.15
C	0.145	0.165	3.68	4.19
D	0.077	0.087	1.96	2.21
E	0.355	0.365	9.02	9.27
F	0.210	0.220	5.33	5.59
G	0.795	0.805	20.19	20.45
H	0.670	0.730	17.02	18.54
J	∅ .130		3.30	
k	0.562		14.28	

- PIN 1. GATE
 PIN 2. DRAIN
 PIN 3. SOURCE

Product Ordering Information

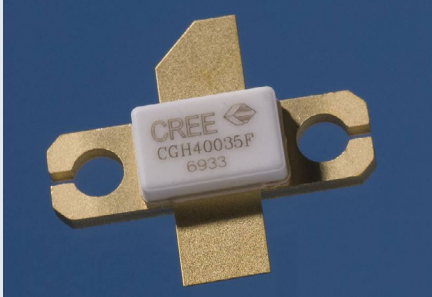
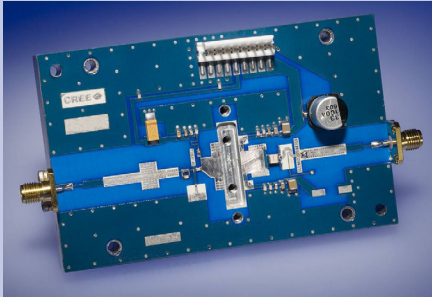
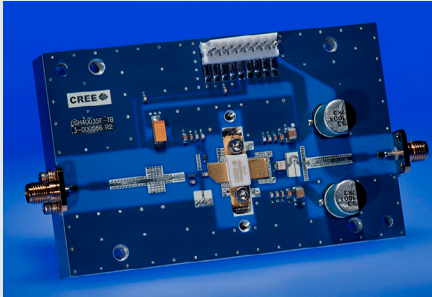
Order Number	Description	Unit of Measure	Image
CGH40035F	GaN HEMT	Each	
CGH40035F-TB	Test board without GaN HEMT	Each	
CGH40035F-AMP	Test board with GaN HEMT installed	Each	



Disclaimer

Specifications are subject to change without notice. Cree, Inc. believes the information contained within this data sheet to be accurate and reliable. However, no responsibility is assumed by Cree for any infringement of patents or other rights of third parties which may result from its use. No license is granted by implication or otherwise under any patent or patent rights of Cree. Cree makes no warranty, representation or guarantee regarding the suitability of its products for any particular purpose. "Typical" parameters are the average values expected by Cree in large quantities and are provided for information purposes only. These values can and do vary in different applications and actual performance can vary over time. All operating parameters should be validated by customer's technical experts for each application. Cree products are not designed, intended or authorized for use as components in applications intended for surgical implant into the body or to support or sustain life, in applications in which the failure of the Cree product could result in personal injury or death or in applications for planning, construction, maintenance or direct operation of a nuclear facility.

For more information, please contact:

Cree, Inc.
4600 Silicon Drive
Durham, North Carolina, USA 27703
www.cree.com/RF

Sarah Miller
Marketing
Cree, RF Components
1.919.407.5302

Ryan Baker
Marketing & Sales
Cree, RF Components
1.919.407.7816

Tom Dekker
Sales Director
Cree, RF Components
1.919.407.5639